



KATALOG

SYSTEM

CORAL

CORAL LUX

Tel. +4858 7712845
Fax +4858 7712846

e-mail: casma@casma.pl
web: www.casma.pl



16600

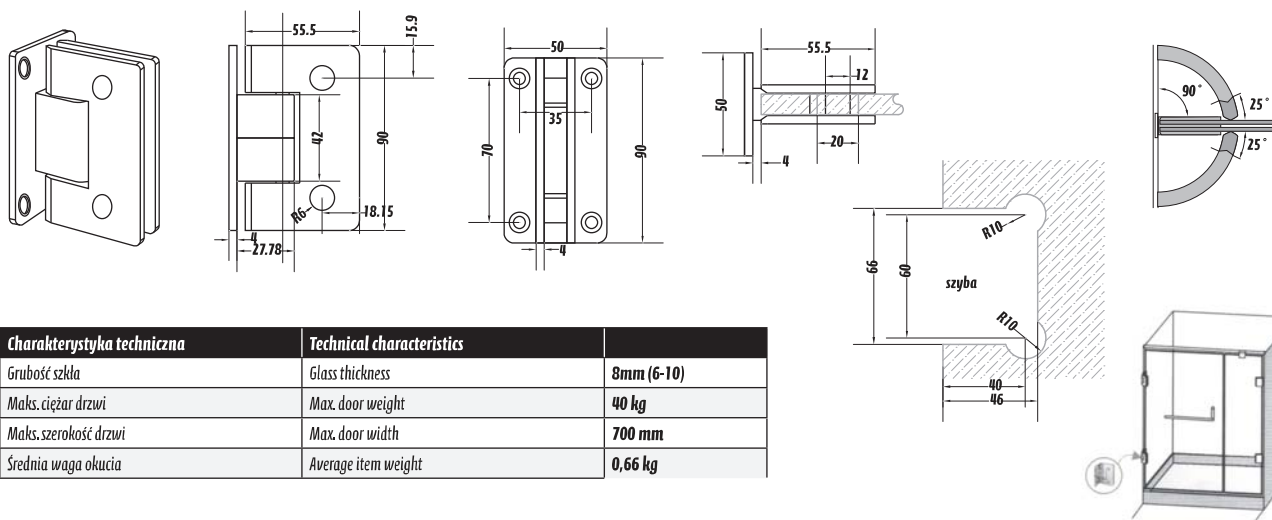

Charakterystyka techniczna	Technical characteristics	
Grubość szkła	Glass thickness	8mm (6-10)
Maks. ciężar drzwi	Max. door weight	40 kg
Maks. szerokość drzwi	Max. door width	700 mm
Średnia waga okucia	Average item weight	0,66 kg

Możliwe wykończenia ■ Available finishes

715

716

780

16601

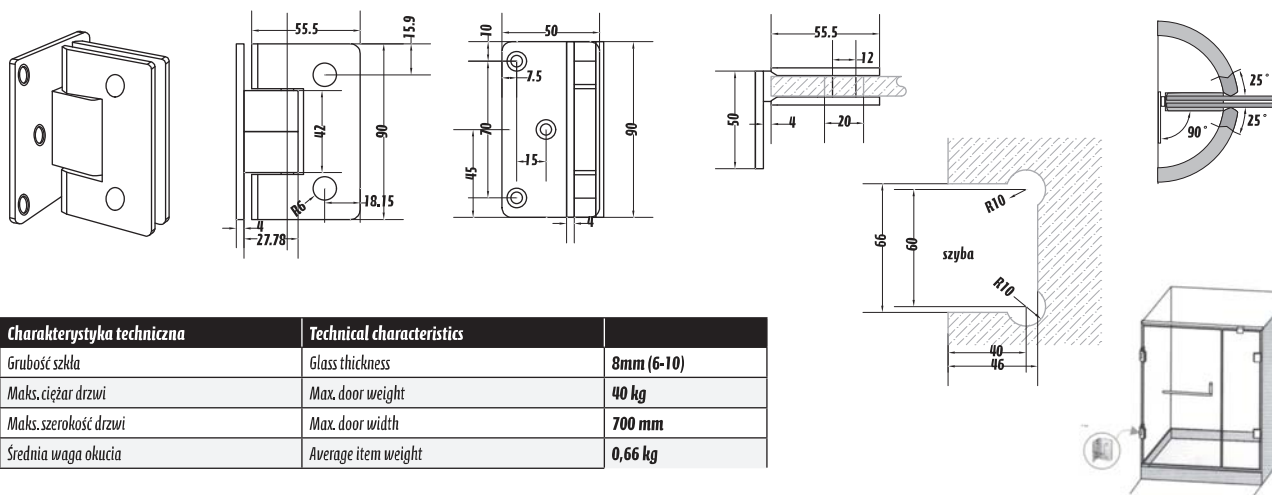

Charakterystyka techniczna	Technical characteristics	
Grubość szkła	Glass thickness	8mm (6-10)
Maks. ciężar drzwi	Max. door weight	40 kg
Maks. szerokość drzwi	Max. door width	700 mm
Średnia waga okucia	Average item weight	0,66 kg

Możliwe wykończenia ■ Available finishes

715

716

780

16635

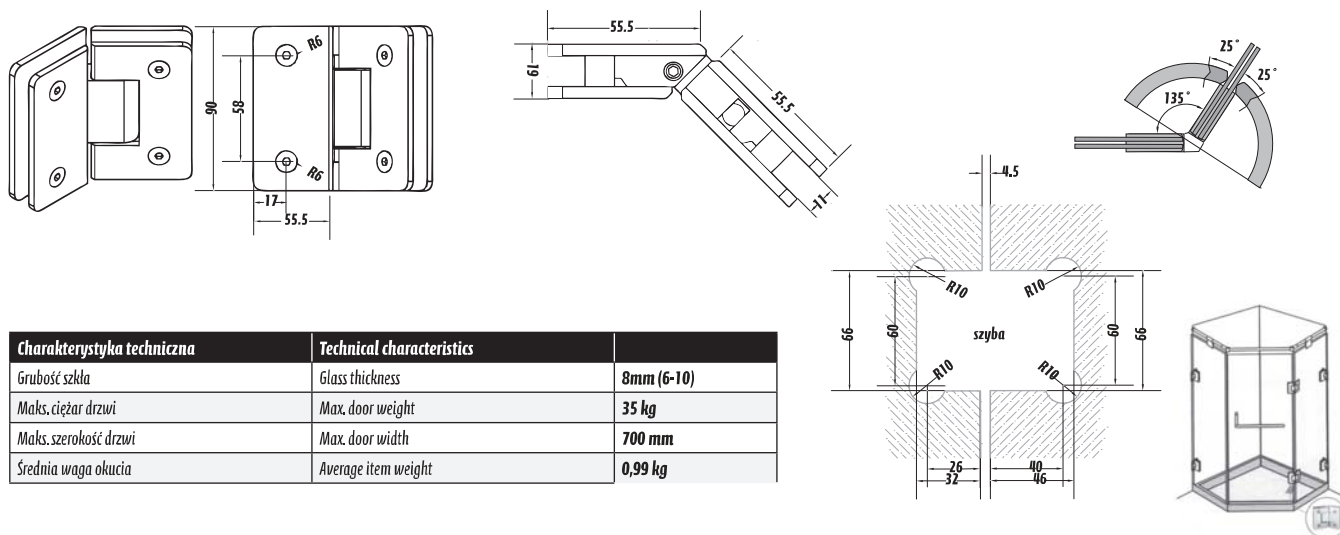

Charakterystyka techniczna	Technical characteristics	
Grubość szkła	Glass thickness	8mm (6-10)
Maks. ciężar drzwi	Max. door weight	35 kg
Maks. szerokość drzwi	Max. door width	700 mm
Średnia waga okucia	Average item weight	0,99 kg

Możliwe wykończenia ■ Available finishes

715

716

780

16680

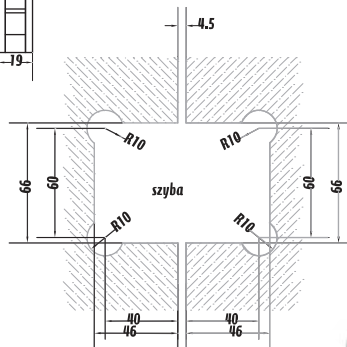
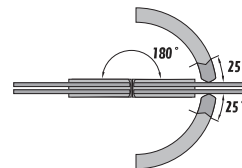
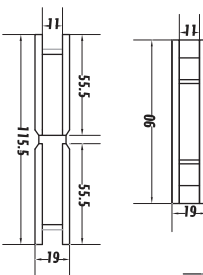
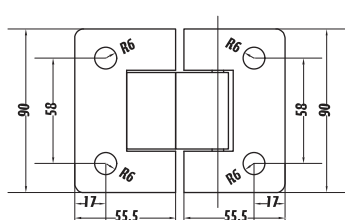
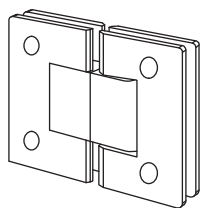

Możliwe wykończenia ■ Available finishes
715
716
780

Charakterystyka techniczna	Technical characteristics	
Grubość szkła	Glass thickness	8mm (6-10)
Maks. ciężar drzwi	Max. door weight	50 kg
Maks. szerokość drzwi	Max. door width	800 mm
Średnia waga okucia	Average item weight	1,04 kg

16690

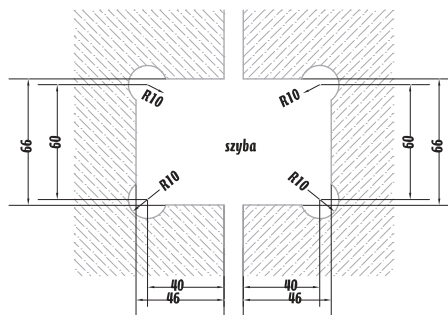
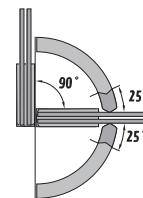
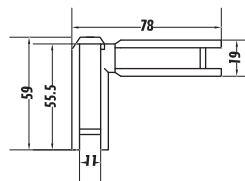
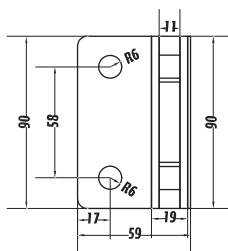
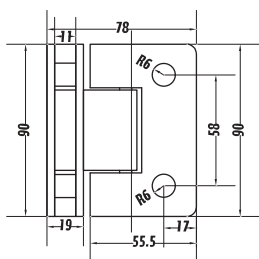
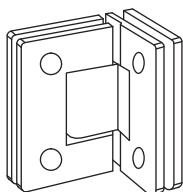

Możliwe wykończenia ■ Available finishes
715
716
780

Charakterystyka techniczna	Technical characteristics	
Grubość szkła	Glass thickness	8mm (6-10)
Maks. ciężar drzwi	Max. door weight	50 kg
Maks. szerokość drzwi	Max. door width	800 mm
Średnia waga okucia	Average item weight	1,11 kg

16200

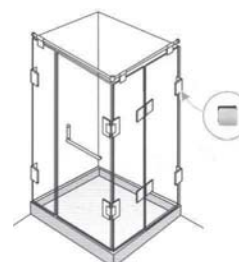
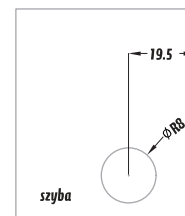
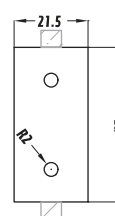
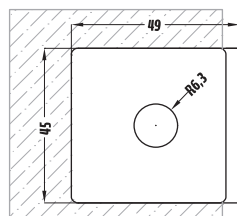
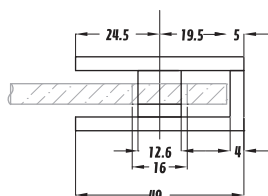
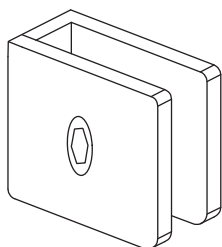

Możliwe wykończenia ■ Available finishes
715
716
780

Charakterystyka techniczna	Technical characteristics	
Grubość szkła	Glass thickness	8 mm
Średnia waga okucia	Average item weight	0,16 kg

16235

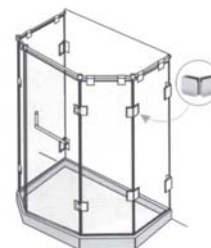
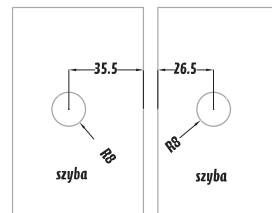
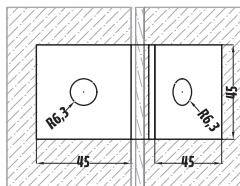
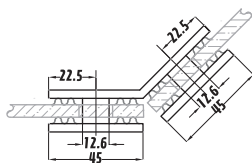
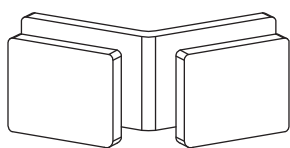

Możliwe wykończenia ■ Available finishes

715
716
780



Charakterystyka techniczna	Technical characteristics	
Grubość szkła	Glass thickness	8 mm
Średnia waga okucia	Average item weight	0,29 kg

16290

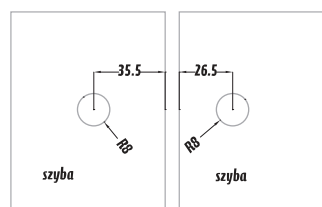
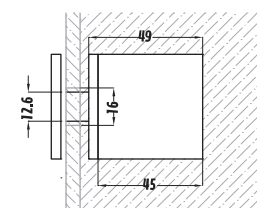
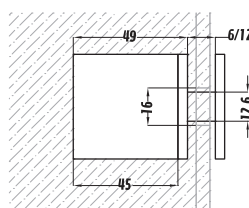
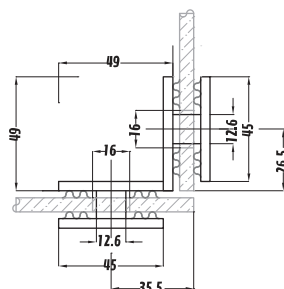
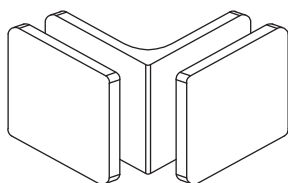

Możliwe wykończenia ■ Available finishes

715
716
780



Charakterystyka techniczna	Technical characteristics	
Grubość szkła	Glass thickness	8 mm
Średnia waga okucia	Average item weight	0,28 kg

D0705

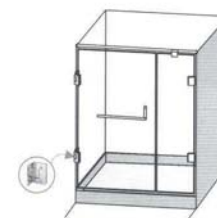
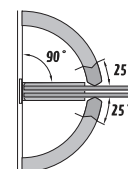
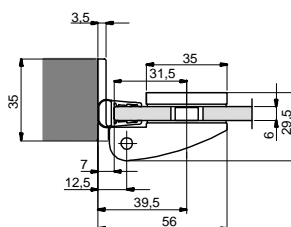
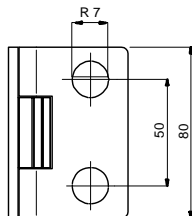
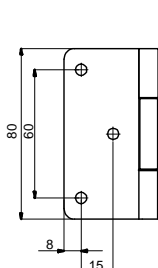
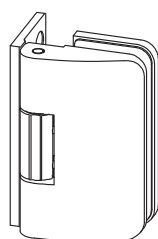

Możliwe wykończenia ■ Available finishes

715
716
780



Charakterystyka techniczna	Technical characteristics	
Grubość szkła	Glass thickness	8mm (6-10)
Maks. ciężar drzwi	Max. door weight	40 kg
Maks. szerokość drzwi	Max. door width	700 mm

D0707

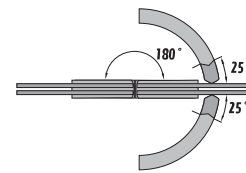
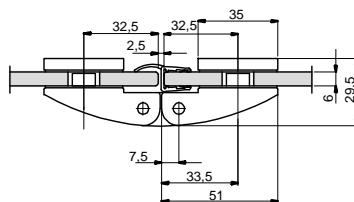
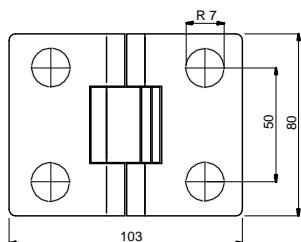
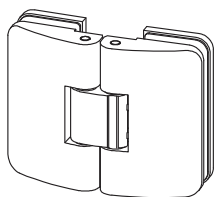

Charakterystyka techniczna	Technical characteristics	
Grubość szkła	Glass thickness	8mm (6-10)
Maks. ciężar drzwi	Max. door weight	35 kg
Maks. szerokość drzwi	Max. door width	700 mm

Możliwe wykończenia ■ Available finishes
 715
 716
 780

D0708

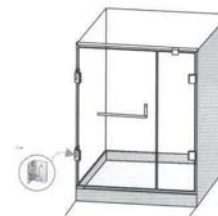
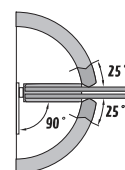
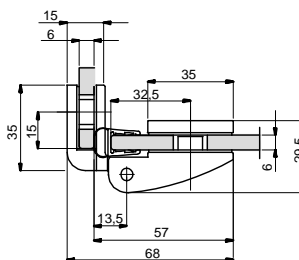
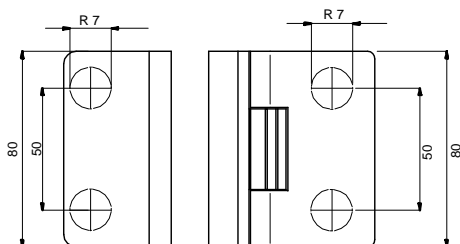
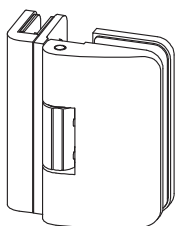

Charakterystyka techniczna	Technical characteristics	
Grubość szkła	Glass thickness	8mm (6-10)
Maks. ciężar drzwi	Max. door weight	35 kg
Maks. szerokość drzwi	Max. door width	700 mm

Możliwe wykończenia ■ Available finishes
 715
 716
 780

D0709

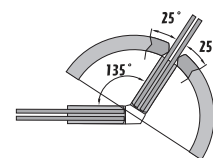
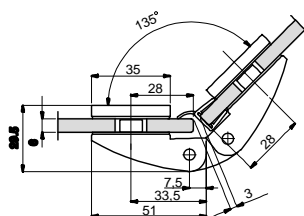
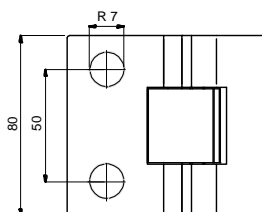
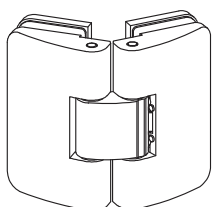

Charakterystyka techniczna	Technical characteristics	
Grubość szkła	Glass thickness	8mm (6-10)
Maks. ciężar drzwi	Max. door weight	35 kg
Maks. szerokość drzwi	Max. door width	700 mm
Średnia waga okucia	Average item weight	0,99 kg

Możliwe wykończenia ■ Available finishes
 715
 716
 780

D0815

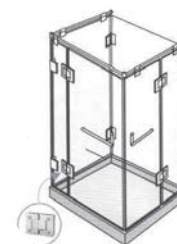
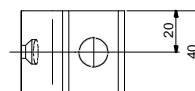
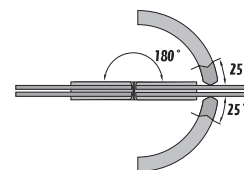
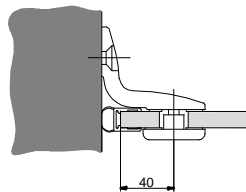
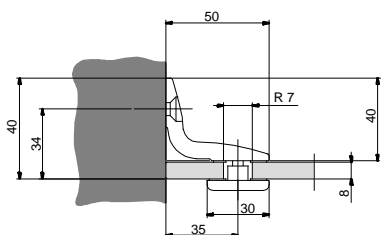
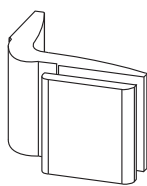

Available finishes
 715
 716
 780

Mozliwe wykończenia ■ Available finishes

Charakterystyka techniczna	Technical characteristics	
Grubość szkła	Glass thickness	8mm (6-10)
Maks. ciężar drzwi	Max. door weight	35 kg
Maks. szerokość drzwi	Max. door width	700 mm

D0816

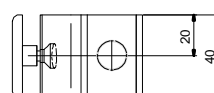
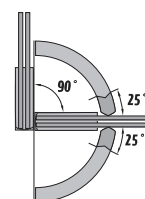
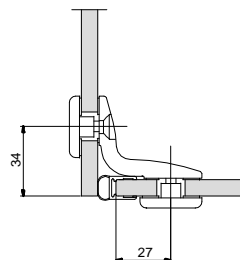
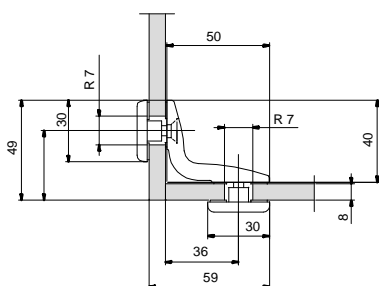
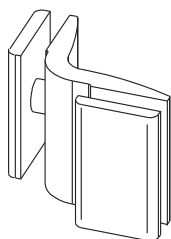

715
 716
 780

Charakterystyka techniczna	Technical characteristics	
Grubość szkła	Glass thickness	8mm (6-10)
Maks. ciężar drzwi	Max. door weight	35 kg
Maks. szerokość drzwi	Max. door width	700 mm

D0817

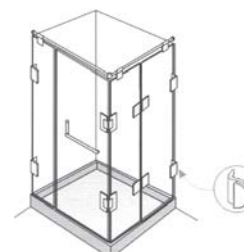
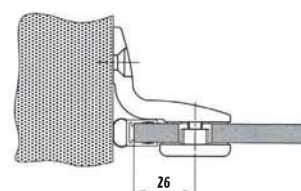
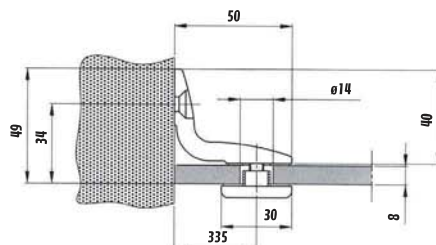
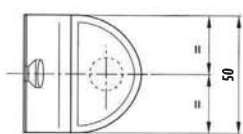

Available finishes
 715
 716
 780

Mozliwe wykończenia ■ Available finishes

Charakterystyka techniczna	Technical characteristics	
Grubość szkła	Glass thickness	8 mm (6-10)
Maks. ciężar drzwi	Max. door weight	35 kg
Maks. szerokość drzwi	Max. door width	700 mm

D0818

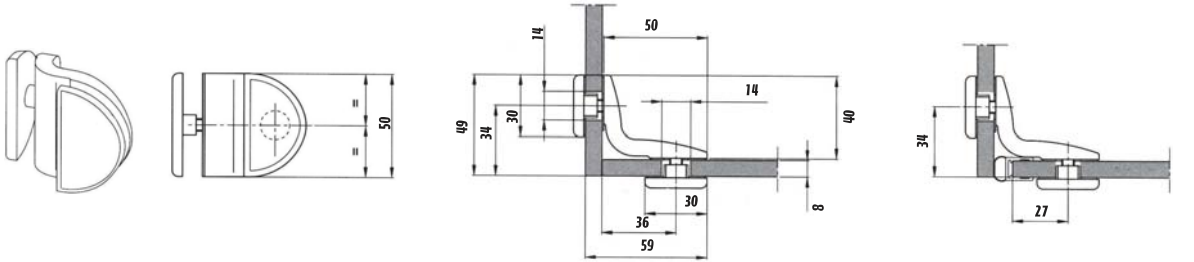

Charakterystyka techniczna	Technical characteristics	
Grubość szkła	Glass thickness	8mm (6-10)
Maks. ciężar drzwi	Max. door weight	35 kg
Maks. szerokość drzwi	Max. door width	700 mm

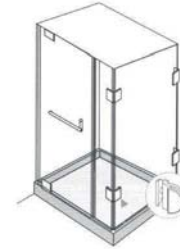

Możliwe wykończenia ■ Available finishes

715

716

780

D0101

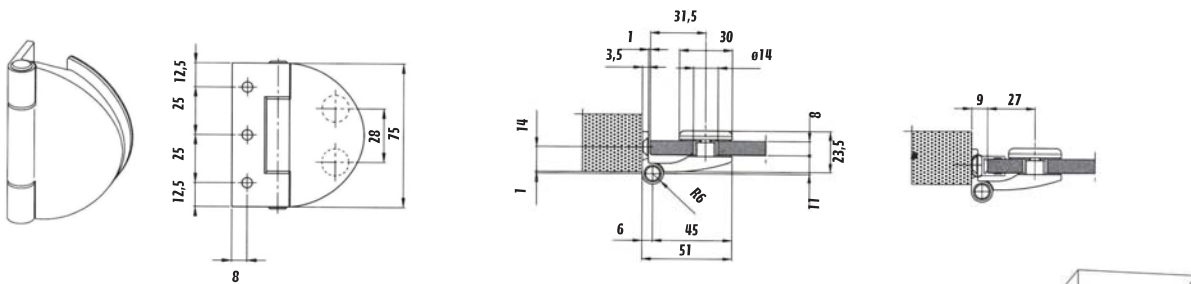

Charakterystyka techniczna	Technical characteristics	
Grubość szkła	Glass thickness	8mm (6-10)
Maks. ciężar drzwi	Max. door weight	80 kg
Maks. szerokość drzwi	Max. door width	800 mm

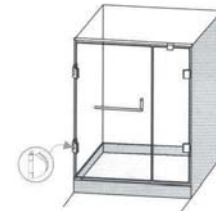

Możliwe wykończenia ■ Available finishes

715

716

780

D0102

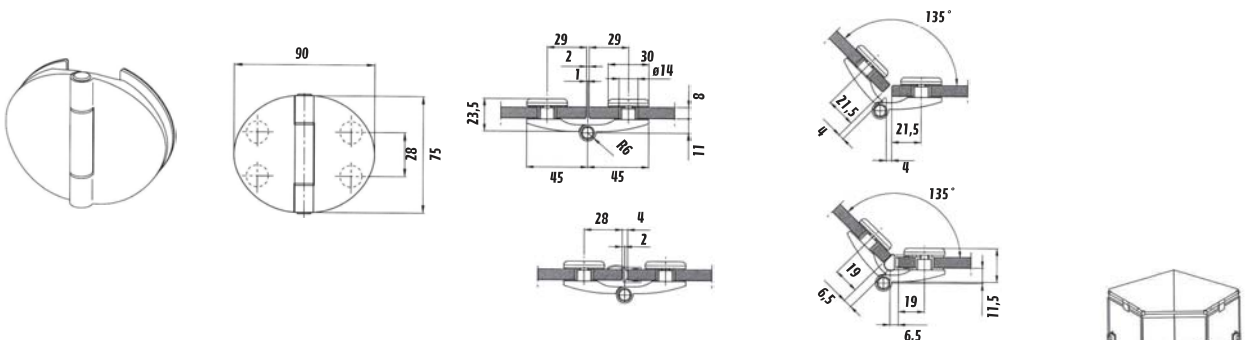

Charakterystyka techniczna	Technical characteristics	
Grubość szkła	Glass thickness	8mm (6-10)
Maks. ciężar drzwi	Max. door weight	40 kg
Maks. szerokość drzwi	Max. door width	800 mm



Możliwe wykończenia ■ Available finishes

715

716

780

D1147 lewe - D1149 prawe

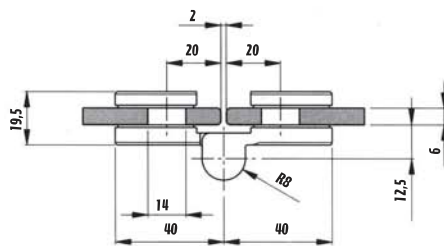
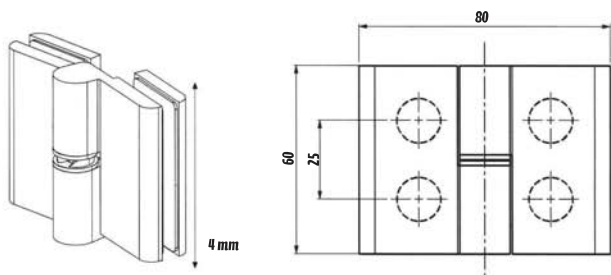

Możliwe wykończenia ■ Available finishes

715

716

780

Charakterystyka techniczna	Technical characteristics	
Grubość szkła	Glass thickness	8mm (6-10)
Maks. ciężar drzwi	Max. door weight	40 kg
Maks. szerokość drzwi	Max. door width	800 mm

D1246

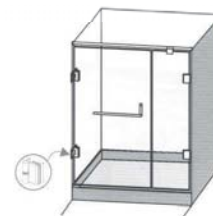
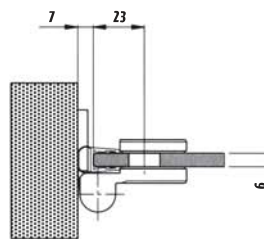
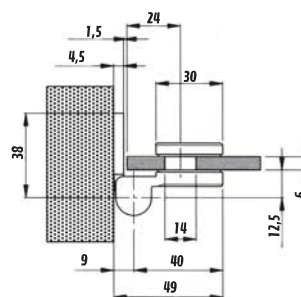
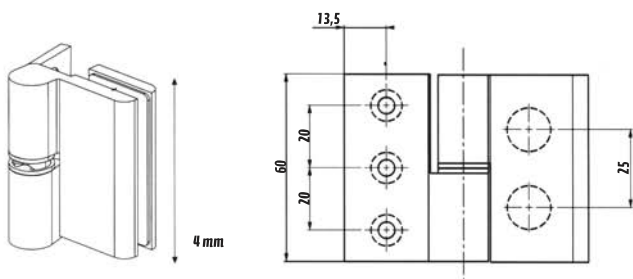

Możliwe wykończenia ■ Available finishes

715

716

780

Charakterystyka techniczna	Technical characteristics	
Grubość szkła	Glass thickness	8mm (6-10)
Maks. ciężar drzwi	Max. door weight	44 kg
Maks. szerokość drzwi	Max. door width	800 mm

I 0102

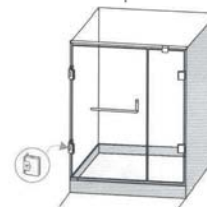
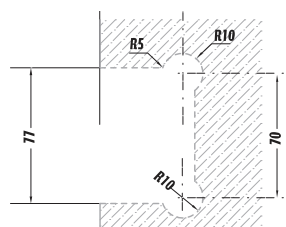
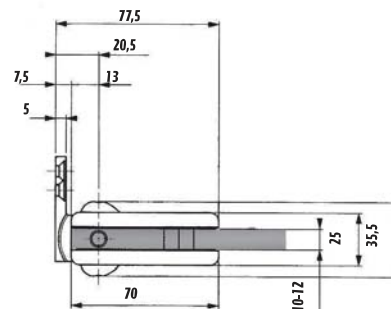
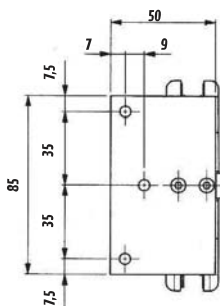
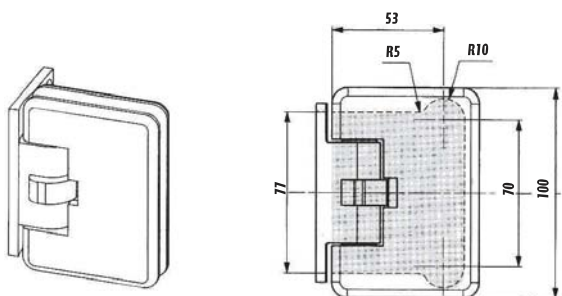

Możliwe wykończenia ■ Available finishes

715

716

780

Charakterystyka techniczna	Technical characteristics	
Grubość szkła	Glass thickness	10mm (8-12)
Maks. ciężar drzwi	Max. door weight	60 kg
Maks. szerokość drzwi	Max. door width	900 mm
Średnia waga okucia	Average item weight	

I 0103

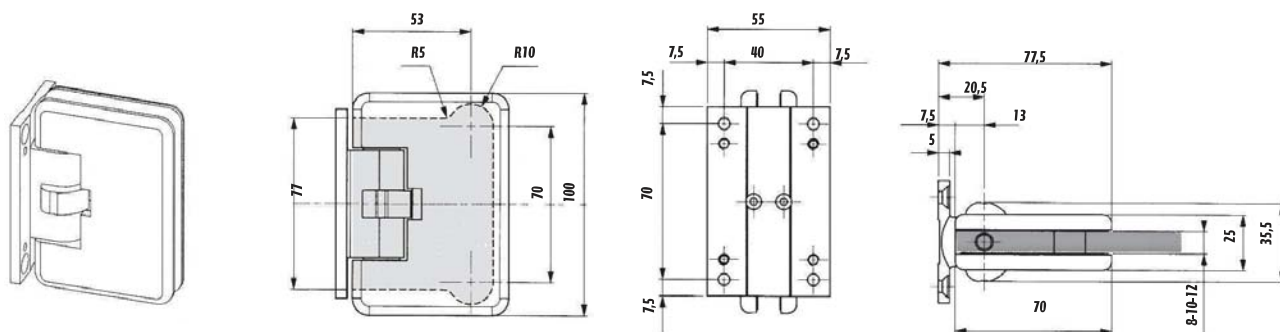

Możliwe wykończenia ■ Available finishes

715
716
780



Charakterystyka techniczna	Technical characteristics	
Grubość szkła	Glass thickness	10mm (8-12)
Maks. ciężar drzwi	Max. door weight	60 kg
Maks. szerokość drzwi	Max. door width	900 mm
Średnia waga okucia	Average item weight	

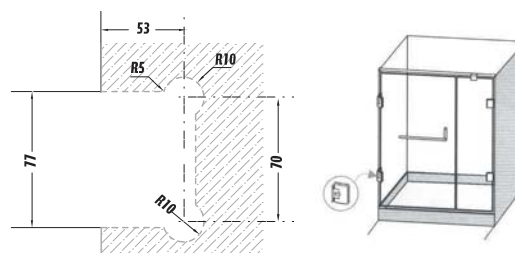

16905

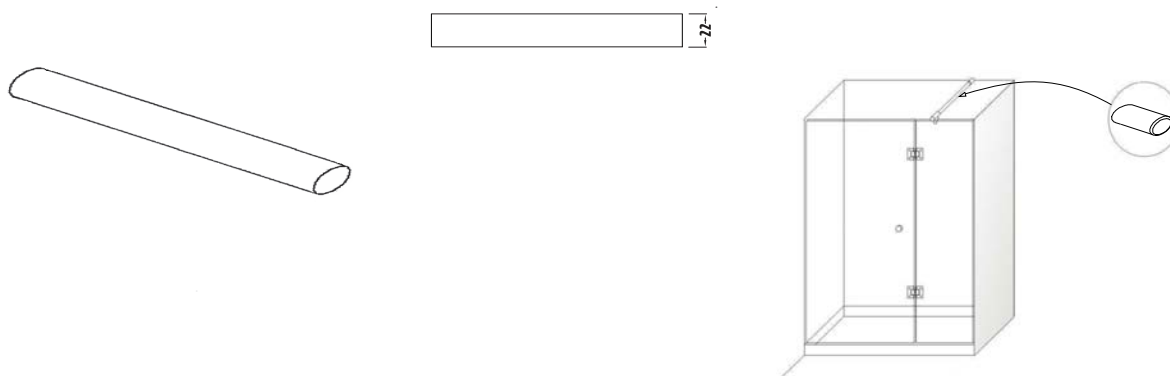

Możliwe wykończenia ■ Available finishes

715
716
780



Charakterystyka techniczna	Technical characteristics	
Grubość szkła	Glass thickness	10mm (8-12)
Średnia waga okucia	Average item weight	0,16 kg

16906

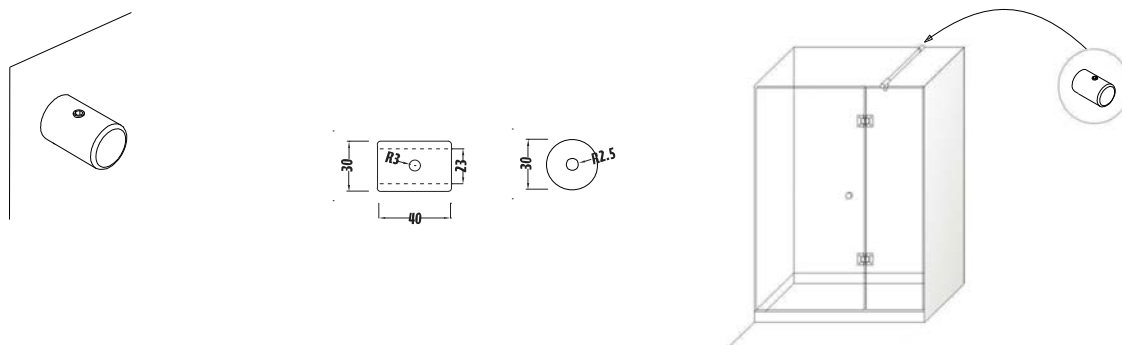

Możliwe wykończenia ■ Available finishes

715
716
780



Charakterystyka techniczna	Technical characteristics	
Grubość szkła	Glass thickness	10mm (8-12)
Średnia waga okucia	Average item weight	0,10 kg

16907

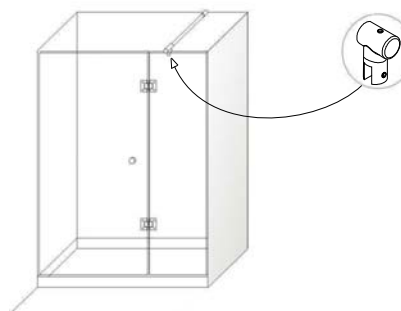
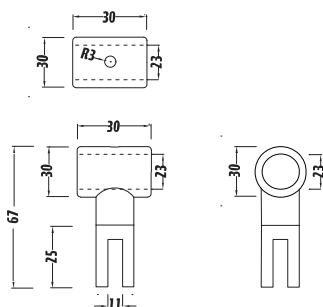
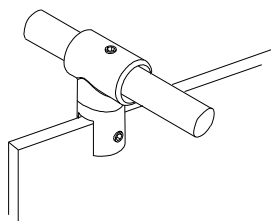

Mozliwe wykończenia ■ Available finishes

715	<input checked="" type="checkbox"/>
716	<input type="checkbox"/>
780	<input type="checkbox"/>

Charakterystyka techniczna	Technical characteristics	
Grubość szkła	Glass thickness	10mm (8-12)
Średnia waga okucia	Average item weight	0,15 kg

16908

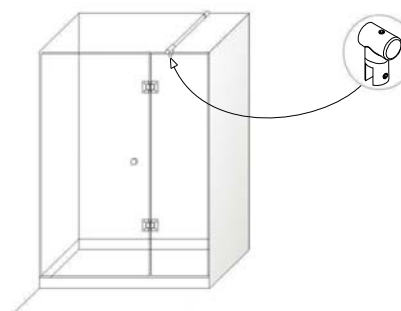
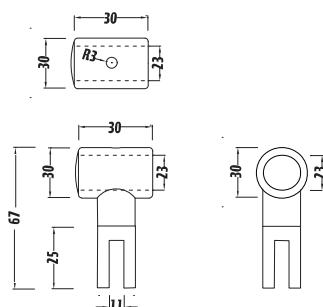
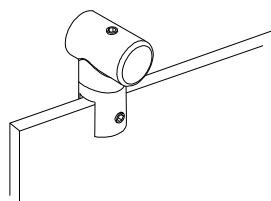

Mozliwe wykończenia ■ Available finishes

715	<input checked="" type="checkbox"/>
716	<input type="checkbox"/>
780	<input type="checkbox"/>

Charakterystyka techniczna	Technical characteristics	
Grubość szkła	Glass thickness	10mm (8-12)
Średnia waga okucia	Average item weight	0,15 kg

16909

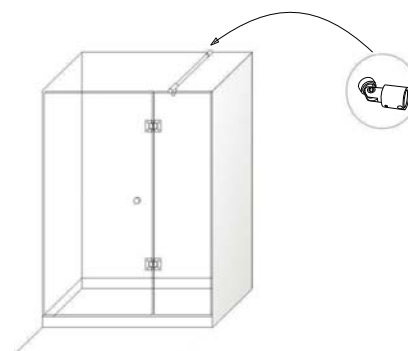
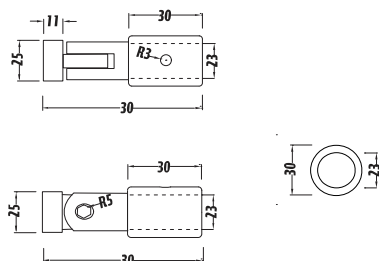
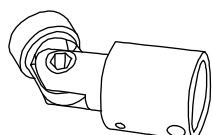

Mozliwe wykończenia ■ Available finishes

715	<input checked="" type="checkbox"/>
716	<input type="checkbox"/>
780	<input type="checkbox"/>

Charakterystyka techniczna	Technical characteristics	
Grubość szkła	Glass thickness	10mm (8-12)
Średnia waga okucia	Average item weight	0,19 kg

16311

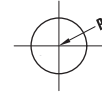
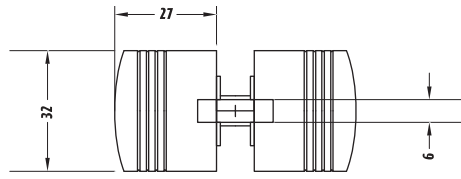
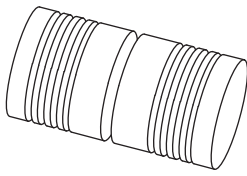

- Modifikaie vykonavacia ■ Available finishes
 715
 716
 780

16312

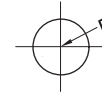
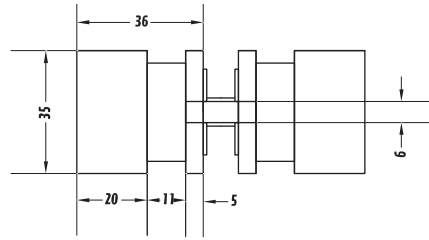
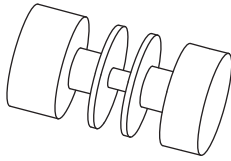

- Modifikaie vykonavacia ■ Available finishes
 715
 716
 780

16313

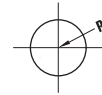
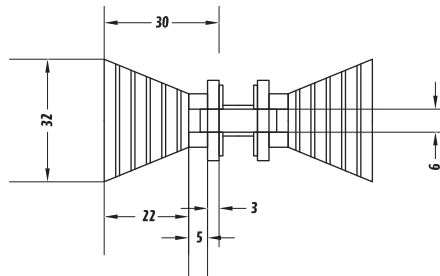
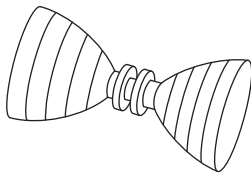

- Modifikaie vykonavacia ■ Available finishes
 715
 716
 780

16314

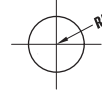
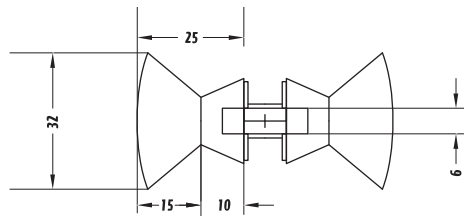
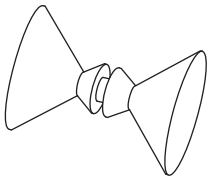

- Modifikaie vykonavacia ■ Available finishes
 715
 716
 780

16315

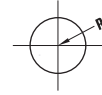
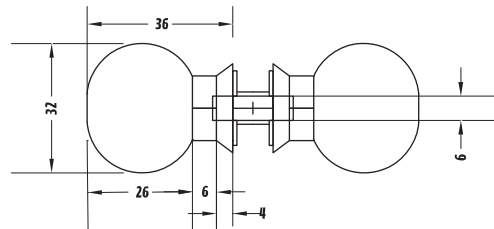
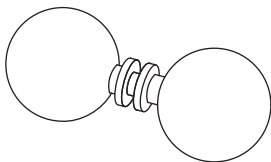

- Modifikaie vykonavacia ■ Available finishes
 715
 716
 780

16316

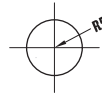
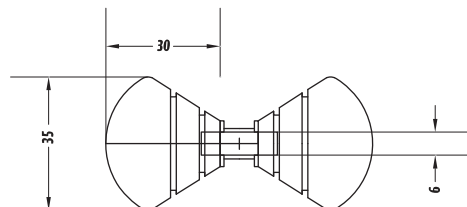
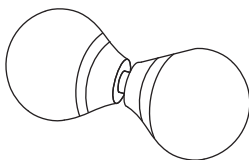

- Modifikaie vykonavacia ■ Available finishes
 715
 716
 780

16036 6-8 mm

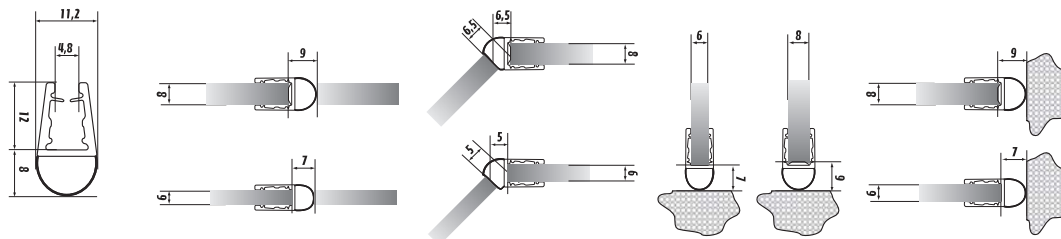

16037 6-8 mm

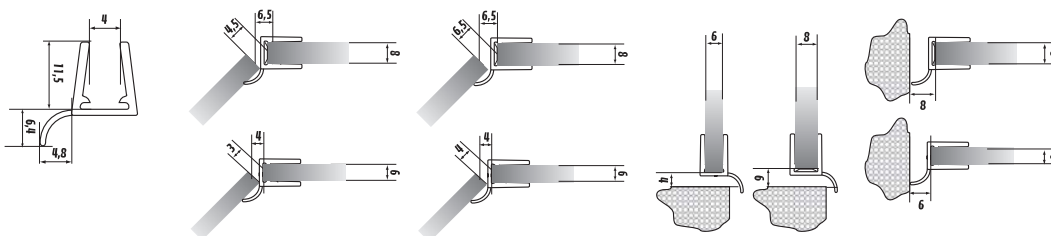

16038 6-8 mm



16039 6-8 mm



16040 6-8 mm

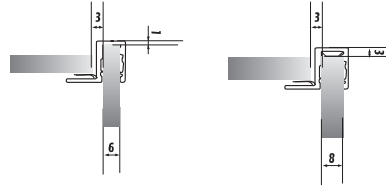
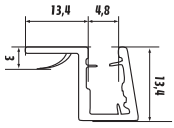

16041 6-8 mm

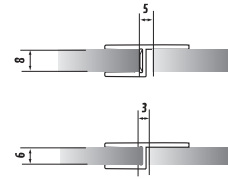
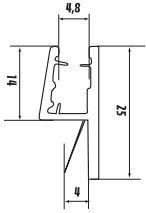

16042 6-8 mm

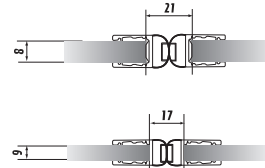
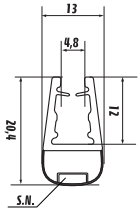

16043 6-8 mm

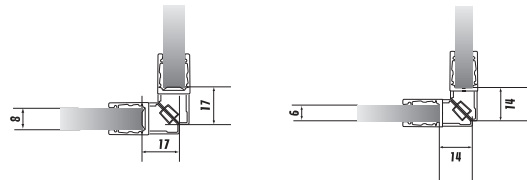
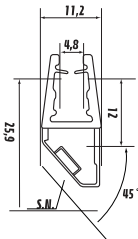

16044 6-8 mm

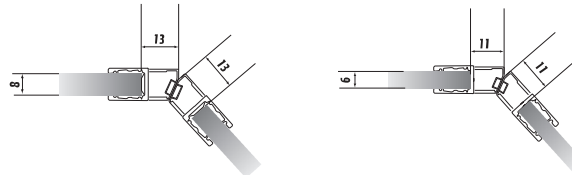
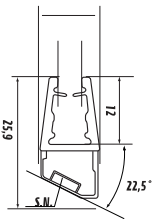

16045

